

Conservation, Testing and Operating an Eddystone 'All World Two', by Gerry O'Hara and Ian McQueen

Introduction

The world is a strange and sometimes wonderful place. It is seemingly full of random connections where elements of chance feed into a series of events, maybe over decades of time, that eventually, without any real intent, planning or design 'come together' to deliver something really worthwhile. It is just such a series of events that brought together the fabric of this article. This is the story of a diminutive Eddystone Medium / Short Wave receiver, an 'All World Two' (AW2) that has a tale to tell - some 75 years in the making - and one that will warm the heart of any Eddystone radio enthusiast.



Part of the tale is told by Ian McQueen, the son of the set's original Australian owner, Dr. George McQueen, and by an Eddystone enthusiast and radio restorer, Gerry O'Hara, VE7GUH/G8GUH recruited (most willingly) by the present owner, Louis Vermond, VE3AWA to conserve, test and render the set operational, as well as prepare this article on the receiver.

Background to the All World Two

In order to understand the significance of the AW2 and appreciate its value and history, it is useful to have an overall appreciation of both the context of the radio in the pre-WWII radio marketplace from both a commercial and technical perspective.

Radio Broadcasting and the Status of Amateur Radio in the 1930's

The years 1924 through 1934 are widely-recognized as being the period of major growth and development within the radio field. A great account of this can be had by reading the excellent book '*Wireless – the Crucial Decade*' by Gordon Bussey.

By the mid-1930's, when the AW2 was introduced, almost all major technical concepts of conventional radio receiver technology had been conceived and many introduced into commercial radio production, eg. superheterodyne (superhet)

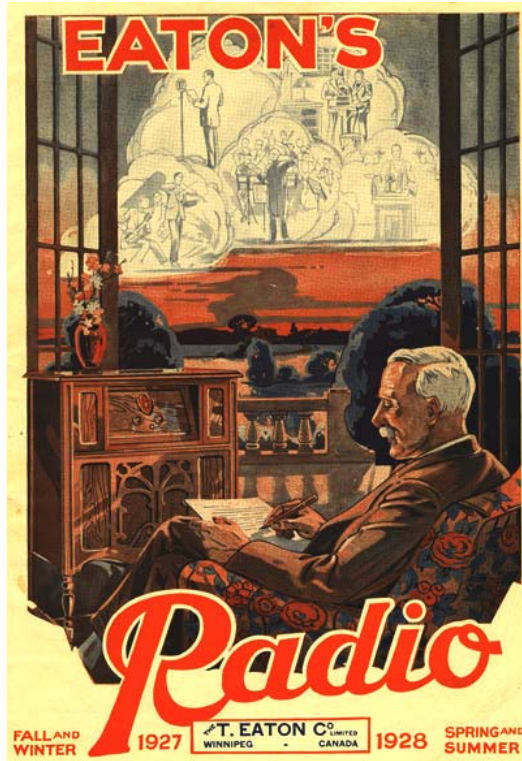

topology, automatic gain control, automatic frequency control, variable selectivity, 'HiFi quality' audio amplifiers and multiple speakers, tone controls, tuning indicators, pre-set tuning, inter-station muting, bandsread etc.

Also, by the mid-1930's, broadcasting had developed from just a few stations in a handful of countries a decade earlier to hundreds (if not thousands) of stations worldwide – broadcasting to local and overseas listeners. In addition, many of the stations were now of higher power (tens or hundreds of kW as compared to hundreds of Watts in the early-1920's). The value of the short wave bands, which in the early 1920's were discounted by the authorities in the field as next to useless, had been demonstrated in

reaching all parts of the globe – opening the doors to 'instant' news and current affairs, cultural exchange, political propaganda etc.

Programming had matured beyond recognition over these years, with stations offering a real mix of programs from news through plays, serials, and comedy shows, with many larger broadcasters even having their own radio orchestra(s). In a pre-TV and pre-internet world, radio enthusiasts were therefore keen and eager to tune-in and take part in this first electronic data and entertainment feast. However, in part, this proliferation of stations necessitated technical improvements to radios so that they would cope with the more crowded conditions on the bands, stronger stations close to weaker stations, increases in man-made interference and the like. So-called 'all-wave' sets started to become popular in the early-1930's, however, they were not cheap – these sets were the high-end audio/home theatre set-ups of their day and the better ones could cost the equivalent of several months salary.



The short wave enthusiast ('short wave listener', or 'SWL') and the radio amateur market of the mid-late 1930's was thus a very different place than it was in the 1920's (and today!). Radio amateurs were up against commercial stations closing-in on their short-wave 'territory', higher levels of man-made interference and the temptation of buying commercially-built receivers from a variety of manufacturers. There were fewer commercially-manufactured transmitters available and radio amateurs mostly constructed their own – a situation that prevailed for several decades after. In the US, companies such as National were producing the famous HRO receivers (photo, above) by the mid-1930's, which could be argued set the standard for the

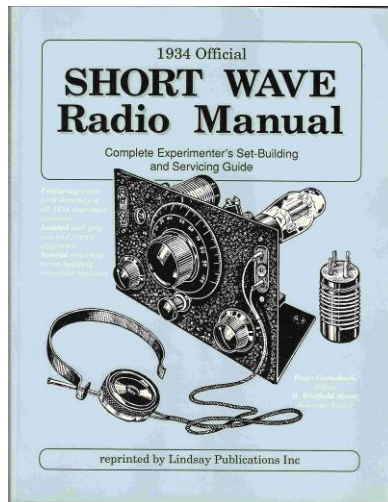

next decade in terms of short wave receiver performance, offering two stages of RF amplification for excellent sensitivity and a crystal filter for razor-sharp selectivity for Morse code (CW) reception. Such receivers were, however 'pie in the sky' for the average radio amateur or SWL. Instead, the radio press in the UK, eg. *Wireless World* and *Practical Wireless*, and in the US, eg. *Radio Craft* and *Short Wave Craft*, was prolific in publishing designs for simple receivers that claimed to be the best and that could squeeze the pips out of one, two or three valves¹. A number of component suppliers provided the necessary parts to supply this

section of the market. Stratton and Co. Ltd, under their trade name 'Eddystone' had been manufacturing radio components since the early/mid-1920's and had become well-established in the UK and overseas as a supplier of high-quality parts, in particularly their range of tuning capacitors/trimmers, coils/formers and tuning dials for use in both receivers and transmitters. They had soon commenced production of complete radio receivers (see below) and also kits of parts for several of their own receiver designs, published in the *Eddystone Short Wave Manual* (ESWM) series of publications (photo, right).

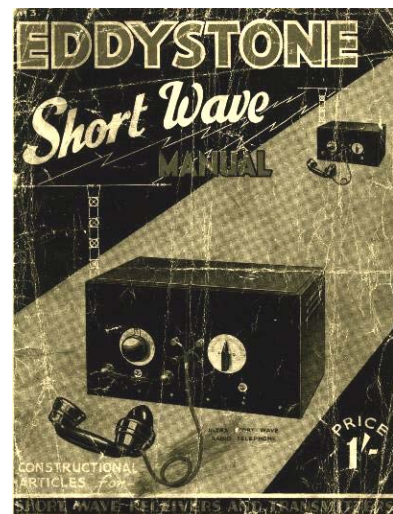

¹ For example, refer to the '1934 Official Short Wave Radio Manual' originally produced by *Short Wave Craft*, edited by Hugo Gernsback and reproduced in 1987 by Lindsay Publications (often still available second-hand). This volume includes many simple receiver designs with enticing claims / names such as 'Reaches the 12,500 Mile Mark', 'Globe Trotter', 'Wonder Set' and 'Tinymite', along with many more complex receiver (and transmitter) designs for the home constructor.

Technical Context

The earliest valve radios in the first quarter of the Twentieth Century were fitted with the only type of amplifier valve available at that time – directly heated triodes (indirectly heated valves were developed in 1924 to allow AC power to be used for the heater circuits). Some designs used these triodes simply as audio frequency (AF) amplifiers following the detector, with the only radio frequency (RF) tuned circuit being present between the aerial and the detector. Where amplification at RF was used, this was in a ‘tuned radio frequency’ (TRF)

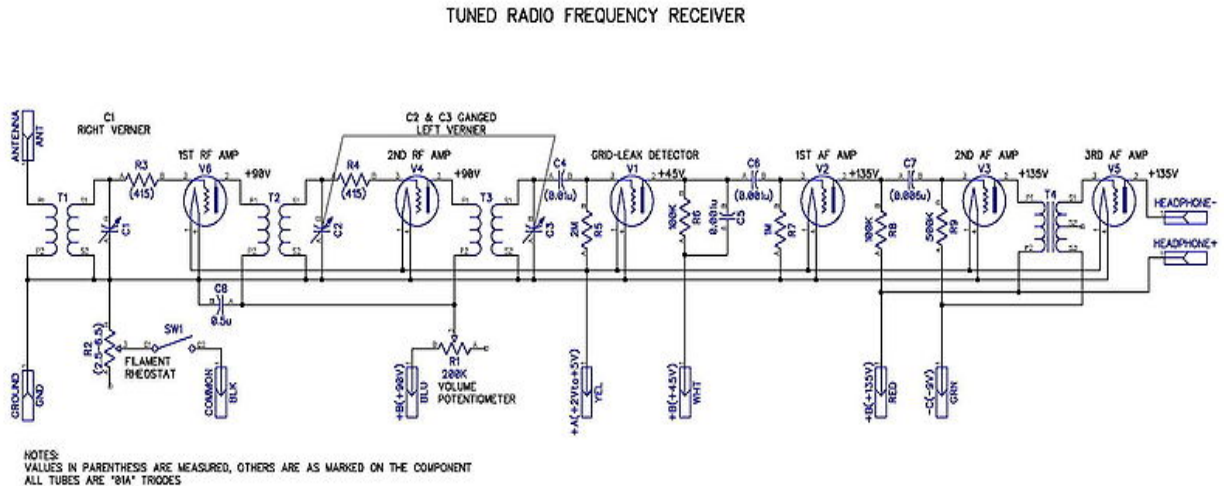

configuration, often referred to as a ‘straight’ design. Sometimes the aerial circuit was un-tuned (‘aperiodic’), with only the detector grid circuit being tuned. All Eddystone sets up to 1934 (except the somewhat mythical 1924 ‘Regional One’ that apparently only had a single valve detector) were of this topology, with varying permutations of RF and AF amplifier stages. This included all designs (kits and built receivers) from the ‘Eddystone Two’ in 1926 (detector and AF amplifier only), through the various ‘Atlantic’, ‘Scientific’, ‘All-Wave’ and ‘Kilodyne’ models, the ‘Homeland’, ‘Empire’, ‘Sphinx’, ‘Overseas’ and ‘Quadradyne’ sets, culminating in the ‘All World Four’ (photo, right) and ‘Homelander’ designs of 1934/35. The ‘Super Six’², introduced about 1934, was Eddystone’s first superhet design (not too successful by accounts in *Lighthouse*), followed by the ‘All World Eight’ in 1936, the latter having a tuned RF stage, mixer, local oscillator, two intermediate frequency (IF) stages, detector and a push-pull AF stage – quite a leap forward in technology.

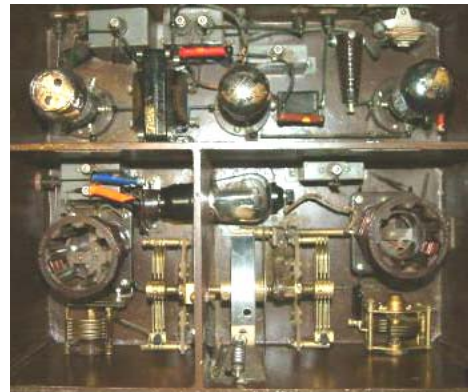

² Not mentioned in the ‘Quick Reference Guide’ (QRG), downloadable from the Eddystone User Group (EUG) website (<http://eddystoneusergroup.org.uk/>), but is covered in *Lighthouse* issues 71 (p15), 80 (p20) and 96 (p44). Very few were made. (‘*Lighthouse*’ and its forerunner the ‘*EUG Newsletter*’ can also be downloaded from the EUG website).

The RF or detector stage was often made to be 'regenerative' in TRF designs, ie. a carefully-controlled level of positive feedback at RF could be applied to the stage concerned using a 'reaction' (also known as 'regeneration') control to increase sensitivity and that could bring the stage into oscillation so CW signals could be detected. Eddystone were rather conservative, in that if RF amplification was used in their TRF designs, only one stage was provided. Other manufacturers, especially in the US, frequently used two or more stages of RF amplification in lieu of the extra gain that could be afforded by the 'fiddly' regenerative detector stage.

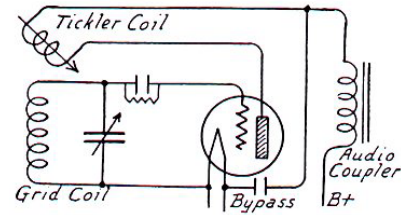

Positive feedback from anode circuit to grid circuit – here via inductive coupling using a 'tickler coil'

The RF amplifier stage(s) in TRF designs suffered from instability due to inter-electrode capacitance ('Miller Effect') causing self-oscillation when too much gain was attempted. The first techniques to overcome this problem were either based around neutralizing the internal valve capacitance, eg. as in the 'Neutrodyne' circuits popular in the mid-1920's in the US, and/or very careful layout and screening of the RF stages. However, it was with the introduction of the screen grid valve³ (tetrode) around 1927 that a significant improvement in front-end stability was achieved, eg. as used in the RF stage of the 1930 Eddystone 'All-Wave Four'. This was followed by the general introduction of superhet technology shortly afterwards, whereby the receiver amplification

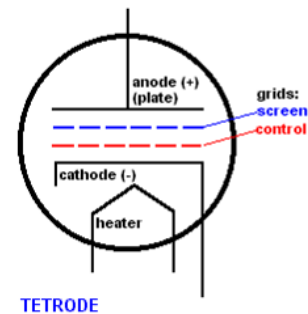

distribution changed to having the majority of the gain performed at a single, lower (IF) frequency, which was an inherently more stable design. The tendency for the RF or tuned detector stage of a receiver to oscillate was, however, exploited in some receiver designs as noted above, whereby control of this was exercised to increase gain and selectivity in 'regenerative' designs. Such designs tended to be simple (one or two valves) and were more for the radio enthusiast than for those who simply wanted to switch on, tune in and listen to radio programs. Another problem with regenerative (reactive) designs is that they can become low-power transmitters if the regeneration is not well-controlled, interfering with nearby radios trying to listen to the same station.

Thus receiver designs by the mid-1930's, were almost universally adopting the superhet topology with screen grid valves in the RF and IF stages over the TRF designs with screen grid valves. The introduction of the pentode allowed yet more gain and stability to be achieved, though with some additional noise at higher frequencies with the earlier valve designs of this type.

³ Screen grid valves much-reduced the Miller Effect, giving higher gain/more stable TRF designs without the need for neutralizing. They were developed in 1919, but not introduced into general use until 1927.

Although by the mid-1930's, Eddystone had ventured (slightly) into the realm of superhet receivers as noted above, their receiver product line mainly comprised of simple regenerative detector designs supplied in kit form (using largely Eddystone-manufactured parts) or as ready-made sets. When compared to superhets, these regenerative designs were much simpler to construct (or manufacture) and were also much cheaper – valves were at the time very expensive⁴ and squeezing the last ounce of value out of them was paramount to the prudent buyer.

The AW2, a regenerative detector and single audio stage two valve set (the popular '0-V-1' configuration⁵) was introduced in 1936 and remained in the Eddystone catalogue through to 1939. The *Quick Reference Guide* (QRG) notes that this set was probably the 'Cinderella' of Stratton in the late-1930's (due to it using receiver techniques from the early-1930's and being firmly in the 'bargain basement' price bracket⁶). However, it was a popular set and it continued to be sold in shops until the outbreak of WWII and was then used by 'Voluntary Interceptors' (V.I.s)⁷ during the early part of WWII before superlative National HRO's and the mighty AR88's were brought in from North

EVERYTHING **S.E.C.** ELECTRICAL

A triumph for the WEMBLEY FILAMENT

**Remarkable new 2-volt
Pentode . . .**



**OSRAM
P.T.2**

Filament volts	2.0
Filament current	0.2 amperes
Anode volts	150 max.
Screen volts	150 max.
Slope	2.5 ma/foot.

By utilizing in the OSRAM P.T.2 the wonderful electrode emissive properties of the New Wembley Filament, a new 2-volt OSRAM Pentode has been evolved, the power output of which is a revelation for its remarkably small H.T. consumption.

The OSRAM P.T.2, used in sets with 1 L.F. stage, or in portables, will give added range, and a volume of undistorted power never before achieved with such a low H.T. current consumption.

If your H.T. Battery is 100 volts, the H.T. consumption is only 4 m.a. If you have 150 volts H.T., you will get more power output and the H.T. consumption will still be only 6 m.a.

In addition, the Wembley Filament ensures absolute reliability by enabling adequate electrode clearances to be used, and an emission which is lasting and sure.

WRITE for the Osram Wireless Guide (1931 Edition) and also Station Indicator Card sent free.

Osram
2 VOLT BATTERY
Valves

SOLD BY ALL
WIRELESS
DEALERS

BRITISH PRODUCTS DESIGNED
FOR BRITISH RADIO CONDITIONS

SUPREMACY IN RADIO - S.E.C. Radio

Advt. of The General Electric Co. Ltd., Magnet House, Kingsway, London, W.C.2.

⁴ At one point a royalty was paid on each valvholder in a set – another reason to keep the valve count down and maximising what the valves you did have could achieve.

⁵ This nomenclature was often used to depict the line-up of valves in a set. The 'V' stands for the detector valve, with the preceding digit identifying the number of radio frequency amplifier valves and the subsequent digit the number of audio frequency amplifier valves.

⁶ The QRG notes that it was offered in 1936 as a kit (plus valves and case) for £3 7s 6d or ready-built and tested (complete with valves and case) for £5 5s, falling to a mere £3 17s 6d by late-1939. The set, complete with headphones and batteries (1930's version of 'plug and play'?) was also offered on 'Hire-Purchase' terms were offered to tempt short wave listeners on a limited income, for only £1 down and six monthly payments of 16s and 4d – the starting pay for an office boy at the time is noted as being around 5s weekly.

⁷ V.I.s were civilian amateur radio enthusiasts and short wave listeners who monitored enemy Morse signals from their homes for military intelligence purposes.

America for this purpose⁸. A full description of the set and its construction from a kit is provided in Issue 3 of the *Eddystone Short Wave Manual* (ESWM3), an extract of the article reproduced here as Appendix 2.

A number of valve types can be used in the set. The ready-built sets were supplied with a Mazda SP210 (pentode) and an Osram KT2 (tetrode⁹) – advert, below. Alternate audio amplifier valves are listed as Mazda Pen 220, Osram PT2 (advert on previous page from *Popular Wireless*, 1931) and Mullard PM22A (pentodes – noted as costing 13s 6d), or Mazda P220, Osram LP2 and Mullard PM2A (all triodes – noted as costing 7s in the article, down from the 1931 advertised price of 10s and 6d in the advert from *Popular Wireless*, right).

THE IDEAL 3-VALVE BATTERY COMBINATION

Here is a 3-valve combination for a battery-operated set, which for efficiency cannot be equalled. It is composed of three famous valves from the Mullard 2-volt range—the P.M.12, screened-grid high-frequency amplifier; the P.M.1 HL, detector; and the P.M.2A, power output valve.

The P.M.12 has recently been re-designed with greatly improved characteristics, while the P.M.1 HL and P.M.2A are among the latest introductions. Three valves as modern as this morning are united in a combination which is in the front line of radio development.

The P.M.12 costs 20/-
 P.M.1 HL .. 8/6
 P.M.2A .. 10/6

P.M.12
P.M.1 HL
P.M.2A

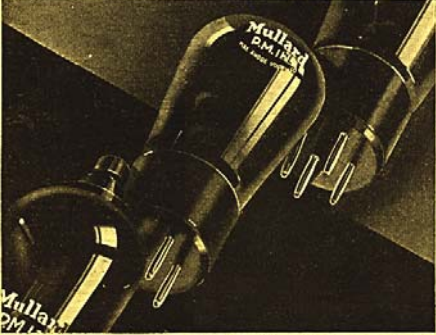

Mullard
 THE MASTER VALVE MADE IN ENGLAND

Advt. The Mullard Wireless Service Co., Ltd., Mullard House, Charing Cross Road, London, W.C.2.

TYPE OF SET	1st STAGE AMPLIFIER	2nd STAGE AMPLIFIER	OUTPUT STAGE	Power Output Watts
2 Volt Battery	HL2 HL2	HL2	KT2 2,KT2 push pull	0.5 1.0
DC/AC	L63 or KTZ63	—	2,KT2C push pull	15.5 Max
AC	KTZ63 KTZ63 KTZ63 L63	— L63 2/L63 push pull 2/L63 push pull	KT61 2,KT61 push pull 2,PX4 2,KT66	4.3 Approx. 11.5 .. 13.5 .. 17-50 ..

Osram PHOTO CELLS **S&C** CATHODE RAY TUBES **Osram** VALVES

⁸ These sets were in a completely different technological (and financial) league to the diminutive AW2 and must have been a revelation to the V.I.s. The AR88's were probably also responsible for hundreds of double hernias and slipped discs, weighing-in at over 115lbs with case, over 19 times more than the AW2.

⁹ The KT2 is a 'critical-distance' tetrode design based on the Harries Patent. This type of tetrode is efficient only in lower power applications (up to half a Watt) and should not be confused with the 'kinkless' aligned-grid beam tetrodes (such as the KT66) which were capable of much higher output power. The term 'kinkless' refers to a tetrode valve that has design features that mitigates an undesirable characteristic of a normal tetrode valve that exhibits a kink in the anode current v anode voltage characteristic curves caused by secondary electrons emitted by the anode reaching the screen grid.

The Set's History

As noted in the introduction to this article, the provenance of this particular AW2 is known and the set has a very colourful early-life, told here by Mr. Ian McQueen, son of the set's original owner:

"The former owner of this Eddystone All World Two (AW2) radio was my father, Dr. George McQueen, late of Adelaide, Australia.

Although my father died in 1989, the AW2 came to light while my wife and I were trawling through my late mother's estate in 2010. We did some research on the internet and found that there were enthusiasts interested in the Eddystone marque - particularly in Europe and North America. The radio was in remarkable condition for its age. It had the original valves and instructions. We were not interested in keeping the radio as a dusty curiosity on the lounge mantelpiece and felt that it would be much better for an interested person or organisation to care for it properly. We contacted the Eddystone User Group in the UK and we gratefully acknowledge the advice received from Chris Pettitt. Given the interest in the radio, eBay seemed a fair way of giving enthusiasts throughout the world the chance to buy it. The radio was sold for what I considered a remarkable price and consequently we were glad to take great care in the packing and delivery to the purchaser, Louis Vermond, in Canada.

Both the original owner, my father, Dr. George McQueen [photo, below] and consequently the radio itself have an interesting history:

Born into a farming family in 1906 in the State of Victoria, Australia, it appears that George McQueen was recognised by his parents as being a bright student. At the age of 12, he was sent to live with his maternal uncle in Launceston, Tasmania. His uncle was the mathematics teacher at Launceston Grammar School. Later, he spent his last year of school at Scotch College, Melbourne. He enrolled in the Medical School at the University of Melbourne at the remarkably young age 16 and graduated with a medical degree (M.B.,B.S.) in 1928 at only 22 years old. He took up a position in the Launceston Hospital and later became a General Practitioner (GP) in rural Tasmania.



However, the Great Depression and WWII had extraordinary impacts on the lives of people all over the world. For Dr. McQueen, the Great Depression meant few patients could afford to pay (Australia did not have today's universal Medicare scheme of pharmaceutical prescriptions and medical services heavily subsidised by the Australian Government). He remarked that "Most people did not call a doctor until the patient was close to death. It was often too late to do anything". Like most others in self-employment in rural Australia (and elsewhere), the Great

Depression caused the rapid loss of the modest personal wealth he had built up in the years since graduation. To avoid becoming dependent on meager Government assistance (like many thousands of other young men in Australia), he applied for a position as a Medical Officer in New Guinea (in those days, the eastern half of New Guinea was administered by Australia, while the western half was administered by The Netherlands). The job was secure and the Australian Government paid for additional training in tropical medicine. He moved to Madang [map, right] on the north coast of New Guinea, and life became reasonably settled again, although of course highly isolated and at times highly challenging. The Australian Government gave its employees generous amounts of paid annual leave so that they could travel to their home states occasionally and recuperate.



Official and personal communications generally took the form of written memorandums and letters. Periodically, trading ships brought basic commodities to the local general store and offered the chance of shopping for something more exotic. It may have been on one of these visits by a trading ship in the late-1930's that Dr. McQueen bought the AW2. Alternatively, he may have bought it on one of his periods of annual leave in Australia. Whatever the case, it would have fulfilled an increasing desire to have a contemporary knowledge of what was happening in the world beyond Madang – particularly in the politically highly-charged year preceding WWII. It was known that the Japanese were relentlessly advancing southwards through east and south-east Asia. For my father, the AW2 was economical, conveniently portable and ran on batteries. It provided the means to listen to radio reports from all over the world. By the early-1940's, the Japanese were within striking range of northern New Guinea. They had conquered present-day Indonesia (just to the north of Australia) and the Philippines. Madang itself was bombed. Fortunately for the radio, the main target was the local gaol - the Japanese pilots probably thought that it was a military barracks – an understandable mistake, but a terrifying experience for the prisoners. The Australian civilians in Madang asked the Australian Government for evacuation. However, the Australian Government said that it was not possible (around this time, the city of Darwin in northern Australia was extensively bombed - over 60 air raids, a commuter ferry, the HMAS Kuttubul - being used at the time by the Australian Navy - was torpedoed and sunk inside Sydney Harbour, and a Sydney beachside suburb was shelled from a submarine).

Rather than wait to see if the Japanese invaded (which indeed happened shortly afterwards), the Australian civilians decided to abandon Madang and retreat inland through then-unexplored territory to Mount Hagen in central New Guinea [map on previous page]. Dr. McQueen was again faced with having to lose virtually everything he had acquired and take the bare minimum for the journey. It seems that he took a Bible, medical supplies, the AW2, an 8 mm Bell and Howell clockwork movie camera, movie films, some clothes and little else. They negotiated their way on foot across tropical and mountainous terrain of northern New Guinea to Mount Hagen with the aid of a school atlas. Eventually they returned to Australia, together with the AW2. Once back in Australia, Dr. McQueen enlisted in the Australian Army and was allocated to a medical unit. After some time passed, the Army realised that Dr. McQueen had invaluable tropical medical experience that would be of benefit to the Australian Army units being sent to New Guinea to resist the advance of the Japanese. His role was to educate both the Australian and US Army in public health practices to prevent the troops being debilitated by tropical diseases, such as Malaria and Typhus. It seems likely that the AW2 radio stayed in Australia at this time.

At the end of WWII, Dr. McQueen married and moved briefly to Sydney and then to a position in the Department of Public Health in the South Australian State Government. His interest in short wave radio was maintained by the purchase of a Philips multi-band receiver in the early-1950's. It plugged into the standard Australian 250V AC power points and had a loudspeaker – no more batteries or headphones required!

The AW2 thereafter settled into a very long hibernation at the bottom of a kitchen dresser, where it remained until 2010. The dresser moved from one family house to another, and the radio simply moved with it. For most of the last 50 years, the dresser was consigned to the shed, and the radio was joined by various household cast-offs, old income tax records and miscellaneous tools. The radio survived the periodic purges of unwanted household items, which are put out on the footpaths for later collection by large local government rubbish trucks. The climatic conditions were severe: Adelaide ['A' on map, right] has a hot, dry climate, like southern California, with minimum temperatures down to about 5°C in winter and occasional highs of 45°C in summer. However, these conditions seem to have aided its preservation. The radio needed minimal work on its components to achieve operation – a truly remarkable outcome after being switched off for more than 50 years.”

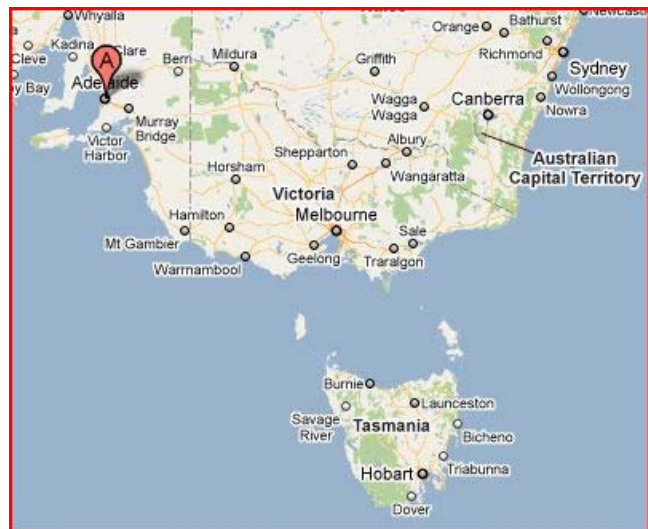

Circuit Description and Construction

As noted earlier, the AW2 is a 0-V-1 topology receiver of very simple design. The article in the ESWM3 notes:

'The theoretical circuit embodies a screened H.F. Pentode valve followed by an audio stage which can use either triode or pentode valve as desired. The aerial input circuit, although simple in design, was only satisfactorily developed after protracted experiments on many types of aerials. It ensures complete freedom from tuning blind spots¹⁰, thus saving the extra cost of an H.F. stage which is the generally accepted medium for overcoming such trouble. Regeneration is obtained by a modified Reinartz¹¹ circuit, feedback current being controlled by varying the S.G. voltage with a potentiometer¹². The high tension battery is suitably isolated to prevent current leakage through the potential divider circuit.'



The AW2 was supplied either as a ready-built set or as a kit of parts. On careful examination of the quality of construction of this set – especially the consistency of the soldered joints, it was concluded that this was most likely a set that had been supplied ready-built from Eddystone.

¹⁰ 'Tuning blind spots' were common in such simple designs, caused by damping of the aerial tuned circuit by excessive loading from the aerial and/or unwanted resonances resulting from stray capacitance/inductances or a combination of stray and circuit component capacitance/inductances.

¹¹ Reinartz was a well-known radio amateur in the early-part of the 20th century. He designed a receiver that would oscillate to whatever frequency the grid was tuned to. The original Reinartz circuit featured a combination of capacitive and inductive feedback using a specially wound 'spiderweb' coil with tapped primary, secondary, and 'tickler' (positive feedback) windings. The primary winding tuned the antenna and provided loose-coupling to the secondary.

¹² Controlling the regeneration in this way, by varying the gain of the valve, provides a much more stable and controllable method than by attempting to vary the coupling between input and output of the valve (in the AW2 circuit, this coupling, provided by a trimmer capacitor, is set once and then not adjusted again).

Circuit

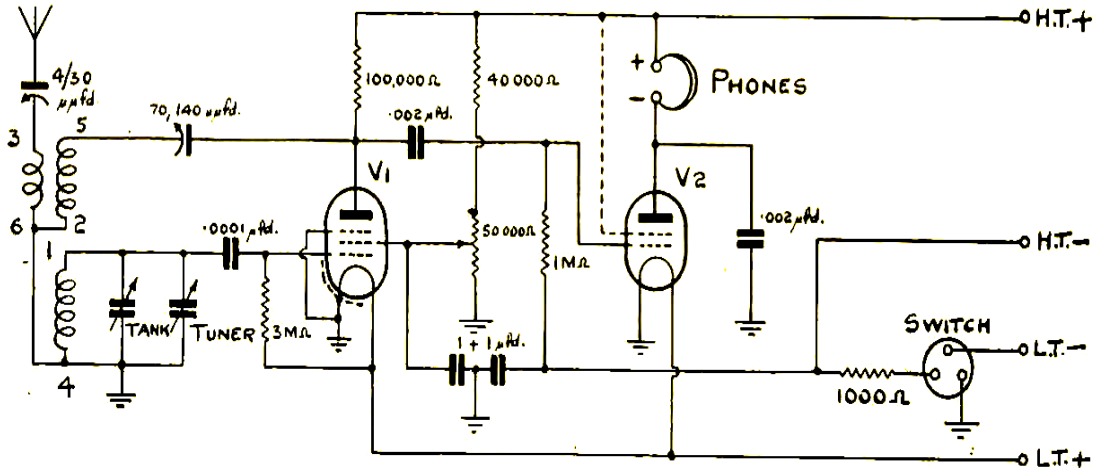

The AW2 circuit is very straightforward (refer to the schematic above): the aerial is capacitively-coupled to the (aperiodic) primary winding of the aerial coil (transformer) via a trimmer (4 -50pF) to adjust for varying types/lengths of aerial. The transformer primary is inductively-coupled to the secondary winding, tuned by the tank capacitor (10-150pF) in parallel with the bandspread capacitor (3-17pF), coupled to the grid of the directly-heated pentode regenerative detector valve (SP210) via a silver mica capacitor (100pF). The grid of the pentode is biased via a grid leak resistor (3Mohm). The anode load of the pentode is a 100Kohm resistor coupled to the HT line (nominal 115v DC). A portion of the amplified RF signal on the anode of the pentode is fed back to the tuned input circuit via a trimmer capacitor (70-140pF) and the small 'tickler' winding on the transformer. Gain of the pentode is adjusted by varying the voltage on the screen grid via the reaction control potentiometer (50Kohm) that forms a potential divider, along with a 40Kohm resistor, from the HT line to ground. The screen grid is decoupled to ground at RF and audio frequencies by a 1uF capacitor. The suppressor grid of the pentode is at ground potential. Detected audio present at the anode of the pentode valve is coupled via a silver mica capacitor (0.002uF) to the grid of the directly-heated tetrode (or triode) AF amplifier valve (KT2). The grid of the AF amplifier valve is self-biased biased via a 1Kohm resistor, decoupled to ground by a 1uF capacitor, and 1Mohm grid leak resistor. The anode load of the AF amplifier is formed by the high impedance 'phones (nominally 2Kohms) and the anode is decoupled at RF and higher audio frequencies by a silver mica capacitor (0.002uF). The on-off switch connects the negative filament supply and negative HT supply (via the 1Kohm bias resistor) to ground.

ONE VALVE SHORT WAVE
HIGH FREQUENCY AMPLIFIER
OR SHORT WAVE CONVERTER.

BATTERY MODEL

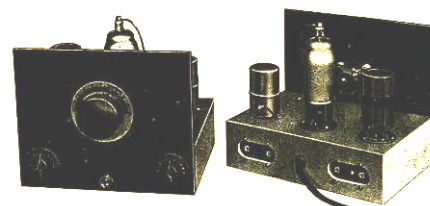

It is interesting to note that the ESWM3 mentions that the performance of the AW2 can be extended by the use of an RF amplifier (a suitable RF amplifier is

described in the same Manual (illustration, at base of previous page).

Passive Components

The quality of the passive components, in particular the coils and the bandspread tuning unit, as well as the use of a rigid die-cast aluminium chassis, really set this radio apart from many other sets of similar circuitry. The bandspread tuning unit was sold as a component 'outfit' by Eddystone at the time, comprising a 'tank unit' ('*Patented Tank Condenser with Knob and Graduated Dial Plate*', #1042) and a 'bandspread unit' ('*Bandspread Condenser Unit with Slow Motion Head, Knob, Dial and Cursor*', #1043). The description in the contemporary Eddystone advert reads thus:

'The "EDDYSTONE" bandspread method of short wave tuning is devised to simplify station selection. Two Condensers are used, the first or Tank Condenser being a compact Air Dielectric unit having a capacity range of 10 x 140m.mfd. This is achieved with a patented stop device graduated in 10 steps. Each step covers a capacity of 14 m.mfd, band settings being accurately pre-determined and controlled by a black bakelite switch knob moving over a metal dial plate graduated 0-10.'

Parallel with the Tank capacity, the "EDDYSTONE" bandspread slow motion trimmer having 9-1 reduction ratio is used. It has a capacity range slightly greater than each separate step of the Tank Condenser. This enables each 10th section of the whole to be spread over 180°, and provides a tuning ratio of 90-1. It gives a definite advantage in short wave tuning, in that a fairly large movement of the bandspread condenser is necessary to effect small changes in tuning, thus separating stations which with generally accepted tuning circuits appear too close to one another to allow clear separation¹³. The trimmer is absolutely noiseless in operation and has a smooth positive control action.'

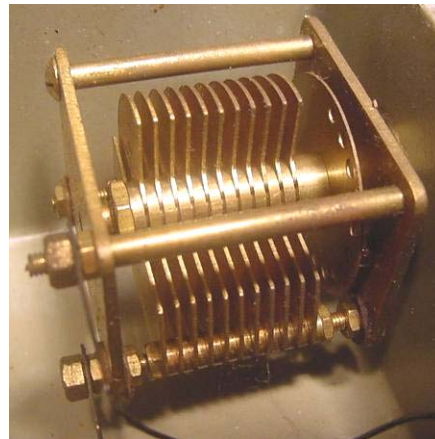

The bandspread and tank capacitors were both of Eddystone manufacture and are of very high quality construction in brass – photos, above: left is the Bandspread capacitor and right, the Tank capacitor (note the 10-position detent plate)

¹³ Maybe a little misleading at face-value: yes, the bandspread would allow greater movement of the tuning knob for any given frequency span covered, however the usefulness of this facility is really limited by the selectivity of the receiver.



Interchangeable Coils for all Waves.
D.L.-9. LOW LOSS DIELECTRIC.

These Coils employ formers made from the new low loss dielectric D.L.-9, a dielectric far superior to bakelite for high frequency use. A complete range is available with 4-pin and 6-pin bases, having two and three windings respectively. The short wave coils are space wound with 22 gauge enamelled copper wire on threaded formers, the higher wave coils being single layer wound with enamelled wire except the long wave coil, which consists of a number of windings in a slotted former. The form shape is such that the coils are highly efficient and also mechanically strong in construction. The range of coils is designed so that 4-pin and 6-pin coils can be used in the same circuit. All wave ranges given are with a .00016 mfd. condenser and are approximate figures allowing for circuit load.

6-Pin Type.				Cat. No. 959.			
Type	Metres	Code	PRICE	Type	Metres	Code	PRICE
Type 6BB	9-14	EXBB	3/3	Type 6P	150-325	EXPI	4/6
Type 6LB	12-26	EXLIB	3/3	Type 6G	260-510	EXGO	4/6
Type 6Y	22-47	EXYEL	3/3	Type 6BR	490-1000	EXBRO	5/-
Type 6R	41-94	EXRE	3/3	Type 6GY	1000-2000	EXDOY	5/-
Type 6W	76-170	EXWO	3/9				

The coils used in the set are from Eddystone's range of air cored 1.5" diameter 6-pin, 3 winding 'low-loss interchangeable coils', #959, that cover 9m through 2,000m in nine ranges (catalogue page, left). These three winding coils (there is also a 4-pin range of two winding coils) were specifically designed for regenerative receiver designs¹⁴. The two coils supplied as standard with the AW2 were '6LB', #959, Code EXLIB (light blue spot), covering 12 – 26m (25 – 11.5MHz)

and '6Y', #959, Code EXYEL (yellow spot), covering 22 – 47m (13.6 – 6.4MHz).

A single mating 6-pin base (#964) is provided on the chassis.

The reaction control potentiometer (unknown manufacturer) is a 50Kohm unit - likely wire-wound, but it was not opened-up to check, described in the ESWM construction notes as a 'Special 50,000 ohm Variable Potentiometer'. This has a very smooth feel to it and is likely a high-quality unit.

Bandspread Tuning Outfit

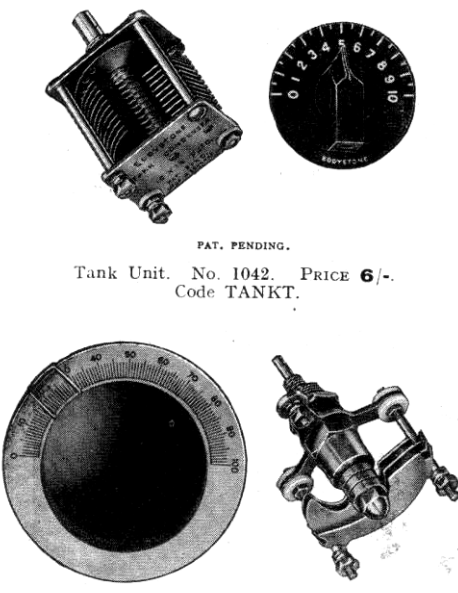

PAT. PENDING.

Tank Unit. No. 1042. PRICE 6/-. Code TANKT.

Bandspread Unit. No. 1043. PRICE 6.6. Code TRIMT.

The "EDDYSTONE" bandspread method of short wave tuning is devised to simplify station selection. Two Condensers are used, the first or Tank Condenser being a compact Air Dielectric unit having a capacity range of 10×14 m.mfd. This is achieved with a patented stop device graduated in 10 steps. Each step covers a capacity of 14 m.mfd, band settings being accurately pre-determined and controlled by a black bakelite switch knob moving over a metal dial graduated 0-10.

Parallel with the Tank capacity, the "EDDYSTONE" bandspread slow motion trimmer having 9-1 reduction ratio is used. It has a capacity range slightly greater than each separate step of the Tank Condenser. This enables each 10th section of the whole to be spread over 180°, and provides a tuning ratio of 90-1. It gives a definite advantage in short wave tuning, in that a fairly large movement of the bandspread condenser is necessary to effect small changes in tuning, thus separating stations which with generally accepted tuning circuits appear too close to one another to allow clear separation. The trimmer is absolutely noiseless in operation and has a smooth positive control action.

¹⁴ An excellent article on Eddystone coils is presented in *Radio Bygones* issue No. 125 (see link from <http://www.epemag3.com/>) and is a 'must read' for anyone that owns some of these coils and would like to identify them and/or put them to good use.

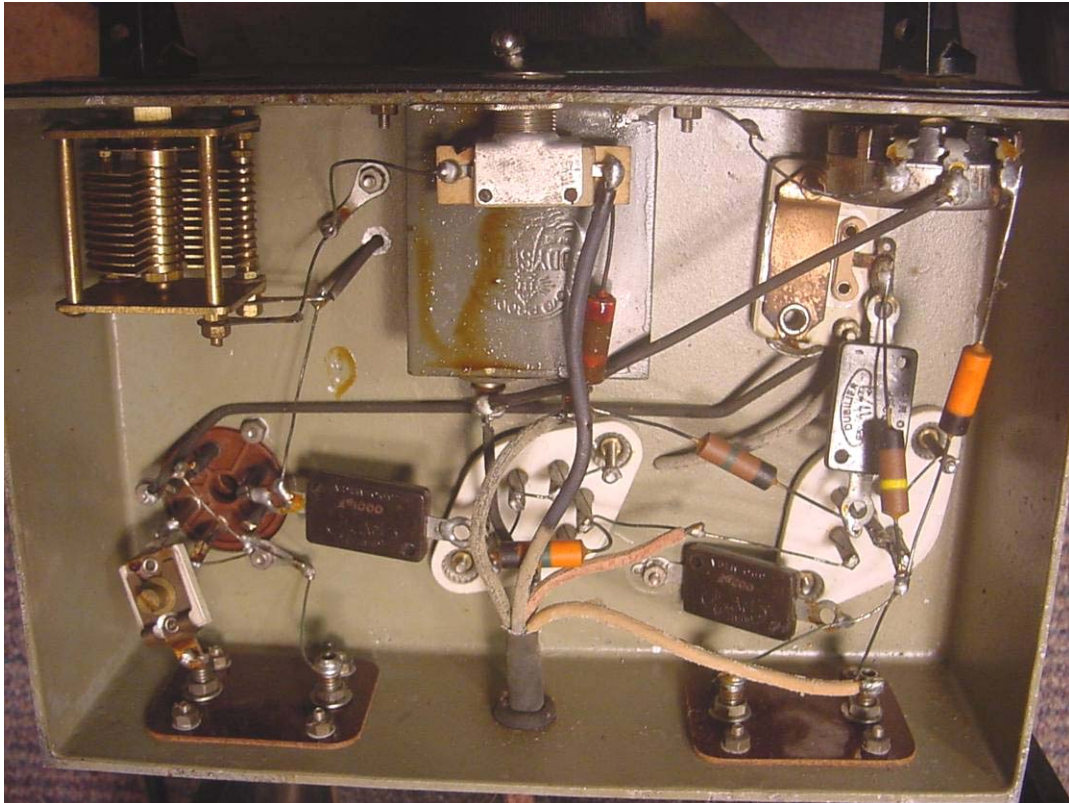

Underside of the AW2 chassis on arrival at the VE7GUH shack – not many components! Note the oil leakage from the twin 1uF capacitor block – otherwise pretty clean and tidy...

The remaining passive components comprise five carbon composition resistors (Erie manufacture), three silver mica capacitors (Dubilier manufacture), two mica compression trimmers – aerial trimmer (*'Eddystone Short Wave Mica Trimmer Condenser'*, #1023) and 70-140 pF reaction pre-set (unknown manufacture), a dual 1uF oil-filled paper capacitor (rated at '500v AC test') in a can embossed with the Eddystone logo, a 'three point switch' (one pole connects to the other two when 'on') of 'Arrow' manufacture, and 1/8" 'Clix' parallel (Wander) sockets for high-impedance 'phones and aerial/ground. The photo above illustrates the under-chassis layout and construction techniques

Valves

As noted earlier, a number of different valve types can be used in the set. The ready-built sets, such as this one, were supplied with a Mazda SP210 (pentode), photo, right, used as



the regenerative detector, and an Osram KT2 (tetrode), photo, right, used as the AF amplifier. The SP210 has a coating of grey metallic paint over the glass envelope that acts as an RF screen, which is connected to pin 4 of the valve. This screen on the supplied SP210 was damaged immediately above the valve base such as continuity with the lower part of the metallization was suspect. Otherwise, the two valves were physically in good condition on arrival.



Construction

The set is constructed on a cellulose-painted aluminium box casting (photo, below) and a crystalline black-finished steel front panel. The chassis is housed in a welded steel cabinet (#1061) finished with the same black crystalline paint as the front panel.



Looking from the front of the set, the RF components are located to the left and center of the chassis, and the reaction potentiometer and audio circuitry to the right. Point-to-point wiring is used throughout (not surprising on such a simple design), however, it is evident that careful thought has gone into the layout – typical of Eddystone – including grounding points and wire dressing to afford reliable operation free of unwanted feedback even at the higher frequencies covered by the set, as well as ergonomics and symmetry of the front panel.



Generally, one component that does not withstand the test of time (and use) too well is rubber insulated wiring. The rubber insulation tends to become either brittle or turns to a sticky 'goo' with age. Although the wiring used in the AW2 is of this type, apart from the ends of the battery wires (where the insulation was very brittle and falling off – photo above, right), the rubber was fairly supple and did not need to be replaced.



Initial Impressions, Testing and Switch-on

The AW2 arrived from Australia exceptionally well-packed by Ian – the coils and valves were wrapped individually in bubble-wrap and placed inside the receiver (photo, right). The receiver was then wrapped in bubble-wrap and placed in a cardboard carton, and this was then placed in a second carton packed in polystyrene peanuts.

I decided to test each of the components as best I could with them in-situ in the set. The only visual clue that there may be something amiss was that there was an oily residue on the twin 1uF capacitor block



(photo, page 15).

All resistors tested within 20% tolerance apart from the 1Mohm one (centre, photo, right), this providing bias voltage to the grid of the AF amplifier valve – rather surprising as many resistors of this age (particularly higher value ones) have drifted well out of tolerance,

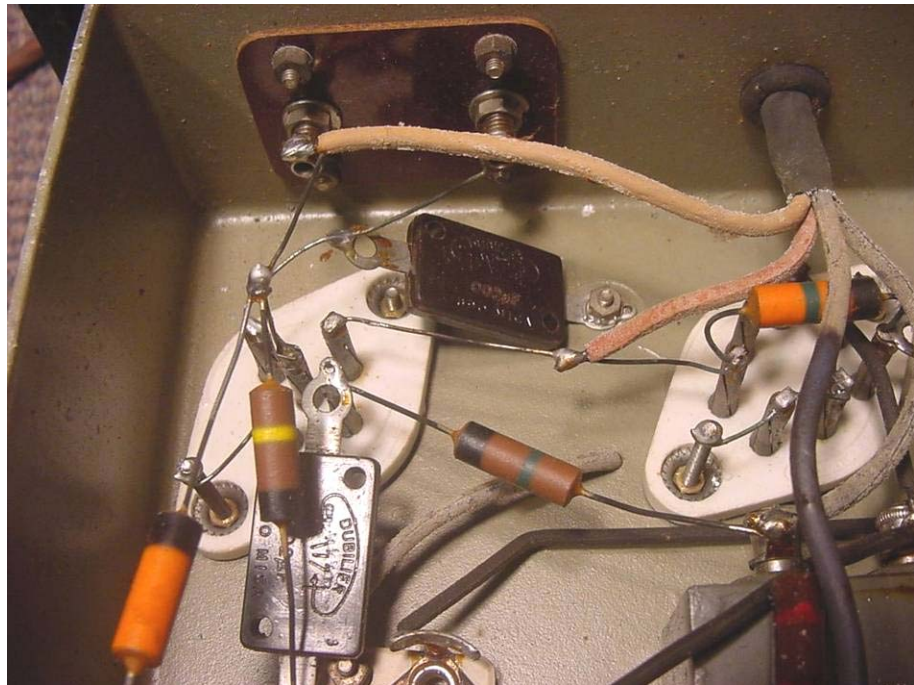

sometimes by as much as an order of magnitude. The value of the 1Mohm resistor was found to be only slightly high (and is not critical), so the original part was left in circuit. The silver mica capacitors showed no leakage and were very close to their marked values. Both coils showed continuity through each of their windings and the tank and bandspread capacitors functioned as they should. The only real issues identified were:

- The potentiometer, while testing at a nominal 50Kohms, showed some erratic behaviour when rotated through its range (likely attributable to dirt on the track); and
- The 3 position switch was intermittent in its action (not always switching both the HT and LT to ground when 'on')

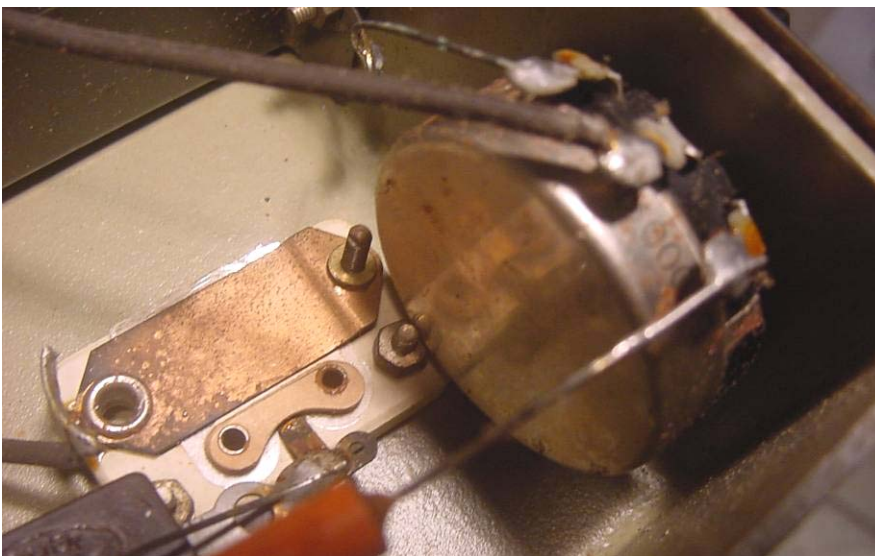

Fixing the potentiometer (photo, left) was left for later as it was still functioning ok, and the switch was operated several times until it was 'on' for both LT and HT and left there for the time being – again to be re-visited later.

With the passive components generally testing ok and the valve filaments having continuity (and my valve testers not having the correct sockets to test them further), I decided to apply some power to the set and see if it worked. I removed my homebrew 'Farm Radio' power supply¹⁵ from the battery console set it had been in for the past year or so and checked it was set for 2v filaments. I removed the perished section of the power supply leads from the AW2 and found that the rubber insulation beneath the fabric sheath was supple and in

good condition. I stripped the insulation back, labeled the wires per the manual and connected them to the power supply. With the valves removed from their sockets, I

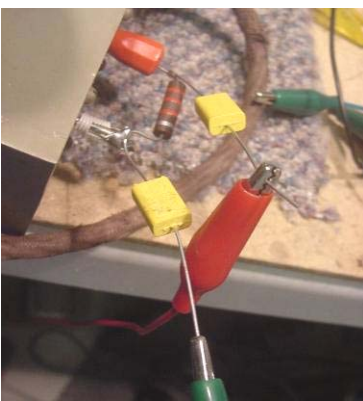

confirmed that the correct voltages were present at the valve sockets and on the anode cap connector of V1. I re-inserted the valves and one of the coils (yellow spot), connected my high impedance 'phones, a short vertical aerial and a ground to the set, switched it on, wound up the reaction control and... silence. After a little fiddling about, I isolated the problem to my 'phones, which had gone open circuit. So, instead, I placed a 2.2kohm resistor across the phones socket and coupled a small (computer-type) amplified speakers across it, isolated using two 0.1uF, 250vw capacitors (photo, left). I switched the set on again



Initial receiver test set-up. The power-supply is to the top left, providing 2v DC for the valve heaters and 135v DC for the anode supply. The two small yellow objects at the lower right of the photo are 0.1uF capacitors feeding a pair of computer amplified speakers. The 2.2Kohm anode load for the AF amplifier valve can be seen between them in lieu of high-impedance phones

¹⁵ 'Farm Radio' is a term often used in Canada and the US for battery-operated sets that continued to be sold to farmers and folks in small towns through the 1930's onwards that did not have an electrical power utility supply ('mains').

– this time I was rewarded with a nice ‘wooshhh’ when the reaction control was wound up, breaking into oscillation if wound even higher. I tuned around a bit and in came some stations and heterodynes – a little practice and operating the three controls became second nature. I set my signal genny to 10MHz, tuned the set until I heard it roaring in, switched the genny off and WWV was heard loud and clear, followed by many other stations on the 31m and 40m bands. Hey, this ‘regen’ receiver lark is good fun – and it is quite amazing what a couple of valves and less than a handful of components can do!

Cleaning-up and Conservation of the Chassis and Case

On opening the case I noted that it contained an ounce or so of fine sand(!) – photo, right, with only minor levels of grime on the upper side of the chassis, some splashes of flux on the underside, and an oily residue along rear edge of the bottom of the inside of the case. There was a minor build-up of fluff and dust on the lubricated parts of the slow-motion drive (bandspread tuning capacitor) and in the tank capacitor, a coating of (leaked) oil on the dual 1uF capacitor can and some oily residue on one resistor (from the capacitor can). Warm soapy water and a small stiff brush cleaned off most of the



remnant grime (photo, left) after brushing off loose dust with a small soft paintbrush and vacuum, the oily residue being wiped clean with lighter fluid. The flux residues were carefully picked-off. Once cleaned, De-Oxit was applied to the tank and bandspread capacitor moving contact surfaces and a little moly grease applied to the tank detent mechanism (ball bearing) and bandspread capacitor shaft ball bearing.

The painted steel front panel and cabinet were generally in good, clean condition. However several areas of bare metal and/or rust were present (photo, right), particularly on the corners/edges and along one side of the cabinet (looks like the receiver had been pushed into a recess and rubbed against something), as well as some isolated areas on the top and base of the cabinet. It was decided not to re-finish the cabinet as the



condition of the paintwork, whilst not perfect, was reasonable and a decision was made by the owner and restorer to conserve rather than restore this set, thus preserving its history. It was therefore decided to stabilize the rusted areas using 'Naval Jelly' (phosphoric acid gel) rust converter/inhibitor applied topically to the affected areas (photo, right). The treated areas were then toned-in to the surrounding paintwork using a black marker pen. In a couple of areas the paint was flaking off and this was to be re-affixed to the underlying metal with a spot of superglue.



The main tuning knob was cleaned with warm soapy water and then polished using Novus #3, #2 and #1. Only the minor scratches were removed, with the deeper scratches



being left in place as patina. The grub screws in the two smaller knobs were stuck tight. Penetrating oil was applied and left in for a week, trying at intervals to loosen the grub screws – but to no avail. Rather than risk breaking the grub screws, it was decided to clean the knobs in-situ, using warm soapy water, then Novus #2 and #1.

The black Tank and Reaction control escutcheons were wiped gently with warm soapy water, as was the bandsread tuning escutcheon. The pencil marks on the bandsread tuning (likely representing favourite stations of Dr. McQueen) were left in place, again to preserve the set's history.

The two plug-in coils were carefully cleaned with warm soapy water and Q-Tips and a light coat of De-Oxit applied to the prongs and to the valve and coil holders.

Final Testing and Initial use on the Air/Comparisons with 'latter-day' Eddystones

Having now cleaned the receiver, and, in particular cleaned and lubricated the variable capacitors, it was time for another air-test, this time with it installed in its case. However, on switch-on, the on/off switch was found to be still intermittent in operation. So, the switch was removed from the chassis, held with the toggle facing upwards and De-Oxit sprayed into the movement. After several such applications and working the switch on/off several times, the contact resistance dropped to less than 1 ohm and its operation was now reliable. The switch was re-installed into the chassis and the chassis back into the case.

My short vertical aerial was again coupled up, as was a ground, my homebrew power supply, together with the external anode load resistor, isolating capacitors and amplified speakers. The set worked much as before, although tuning repeatability was better and the set just 'felt better' looking cleaner, tidier and much as it would have done at the outbreak of WWII.

I lined the set up against a couple of my other Eddystones – my trusty S.750 and Model 1830/1 using the same aerial. Well, ok, I must admit that the AW2 was not in the same league as either of these sets, but it did not put in a hopeless performance. It pulled-in all of the strong and most of the medium-strength stations that the later models did, but, as expected, was much more susceptible to interference from strong stations close to the tuned frequency.

Amateur bands covered by the two coils supplied with the set are 20m, 30m and 40m. I tried it out on 40m to see what sort of bandspread the set had for the Morse code (CW) section of that band (lower 35kHz). The tuning characteristics were found to be as follows (using the 6Y coil):

Frequency (MHz)	Tank Capacitor	Tuning (Bandspread) Capacitor
7.00	6	41.1
7.10	6	30.7
7.15	6	0.0
7.15	5	86.2
7.20	5	76.5
7.25	5	68.9
7.30	5	59.4
7.35	5	49.9

The bandspread capacitor shaft is fitted with a 1:9 reduction drive, giving a ¼ turn of the main tuning knob = 10 divisions of the bandspread scale. Louis Vermont notes that this level of bandspread is useable and better than some sets he has used on the amateur bands. Louis is also searching for the 6W (white spot) and 6P (pink spot) coils to give him access to the 80m (Louis's main interest) and 160m amateur bands.

Some CW signals could be heard on the 40m band, though no phone signals were detected during the times I listened to this band. Nothing much was heard on the 30m

band, but several CW signals were detected on 20m, but the exciting thing was several SSB signals were also heard loud and clear on this band. Ok, well, maybe not exactly stellar performance, but given the poor aerial not unexpected – and, of course, the set was not really meant for amateur band use (and certainly not in 2010!).



Two new old stock (NOS) valves arrived after this initial testing

(a Mullard PM22A and Mullard SP2) and were eagerly tried in the set. Performance was much the same as with the original valves (Mazda SP210 and Osram KT2), though the reaction control needed to be cranked-up a little higher with the SP2 in the set.



What really made a difference though was using a pair of Stromberg-Carlson high-impedance 'phones given to me by Louis – wow, these really made the set more sensitive and really 'come alive' – much more so than the speakers as the 'phones also act as a mechanical audio filter, accentuating speech frequencies.

The full tuning range of each coil was explored with the new valves fitted. A set of calibration curves for the Bandsread dial for each setting of the Tank capacitor was prepared and is posted as a separate document on the EUG website.

Conclusion

The AW2 is a very simple, yet very effective short wave receiver. Considering its low component count (2 valves, 1 coil, two variable capacitors, two trimmer capacitors, 5 fixed capacitors, 5 fixed resistors and one variable resistor) it gives a very good showing for itself on the short wave broadcast bands – it can be seen why it was a popular set for those on a budget and/or those wanting portability (it weighs-in at a mere 6lbs and measures 8.5" x 6" x 7"). What set it apart from many of its competitors is the high-grade components, in particularly the coils and variable capacitors – a mini-showcase for the Eddystone short wave component catalogue. Ease of use was looked-after by the superlative bandsread tuning feature and the very smooth reaction control characteristics. Albeit this set was introduced in the twilight years of the regenerative receiver, when simple TRF sets had become all but eclipsed by the mighty

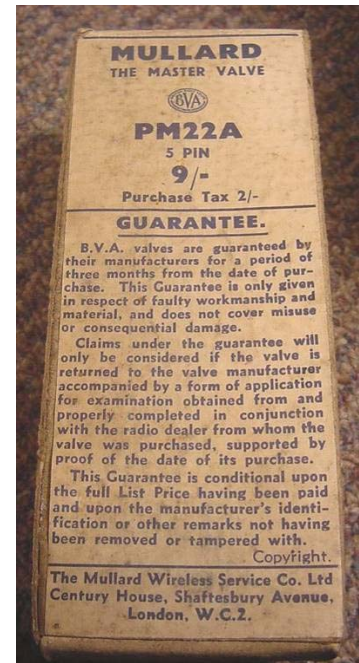

superhets, these characteristics allowed the set to be marketed up to the onset of WWII and used into the war years by the Voluntary Interceptors – quite a remarkable achievement for such a diminutive radio.

Louis, VE3AWA, will be matching-up the AW2 with his single-valver self-excited transmitter having a majority of 1920s era English wireless components. He is planning on using this set-up in the annual *Antique Wireless Association's* (AWA's) 'Bruce Kelley Memorial 1929 QSO Party' in December (www.antiquewireless.org/ - see 'Upcoming Amateur Radio Events').

73

©Gerry O'Hara, VE7GUH (gerryohara@telus.net) and Ian McQueen, with kind permission from Louis Vermond, VE3AWA, September, 2010



Rear view of the AW2 – the original power cord was reinforced with heat-shrink tubing at its point of entry through the case (it had become frayed at this point). The 'phones connect to the left hand sockets and the aerial and earth to the right hand ones

References

- *Wireless – The Crucial Decade. History of the British Wireless History 1924-34*, Gordon Bussey, 1990
- *1934 Official Short Wave Radio Manual*, Short Wave Craft [magazine], Hugo Gernsback (Ed.), reproduced in 1987 by Lindsay Publications Ltd. ISBN 0-917914-64-3
- *The Ultimate Quick Reference Guide* (2nd Ed.), Graeme Wormald, 2002
- *A Century of Achievement. The Laughton Story 1860-1960*
- *Eddystone Coils and How to Identify Them*, Stef Niewiadomski, Radio Bygones NO. 125, June/July, 2010
- *Eddystone 'All World Two' Battery Operated Receiver. Instruction Manual For Installation and Operation* (original provided with set and download from EUG site)
- *The All World Two 15.5 to 52 Metres. A Powerful 2 Valve Short Wave Battery Receiver with Bandsread Tuning*. Eddystone Short Wave Manual Issue No. 3 (ESWM3), pp2-7, reproduced in Appendix 2
- *One Valve High Frequency Amplifier*. Eddystone Short Wave Manual Issue No. 3 (ESWM3), pp34-38, reproduced in Appendix 2
- Advertisements and reviews in *Wireless World* and *Practical & Amateur Wireless* through the 1930's (reproduced in Appendix 4)
- 'Lighthouse' magazine (PDF copies of all the *Lighthouse* magazines and its forerunner the 'EUG Newsletter' can be downloaded from the EUG website, <http://eddystoneusergroup.org.uk/>).

	Issue	Page
- acquisition & description.....	56.....	27
- advert.....	36.....	24
-	44.....	23
-	92.....	30
- cost, new.....	44.....	27
- discussion regarding (Tor Marthinsen) & picture.....	79.....	36
- eBay & pictures of.....	92.....	18
- featured receiver.....	28.....	25
- owned by Davis Fletcher.....	86.....	28
- patent specification.....	92.....	26
- restoration.....	26.....	25
- reviews		
- Wireless World 1936.....	39.....	25
- Practical & Amateur Wireless 1936.....	44.....	2
-	79.....	24
- use in Secret Service.....	92.....	31

Practically all of the history about WWII is now publicly available from Australian Government records and has been published in various ways - there was heavy censorship during the war. The following Australian Government web site is particularly revealing on just how vulnerable Australia had become by 1942. There is also an excellent animation of the audacious attacks by Japanese submarines and ensuing

exchanges inside Sydney Harbour, and the attacks on shipping on the east coast of Australia. This gives the reader a good idea of the backdrop to the failure of the Australian Government to evacuate civilians in northern New Guinea:

<http://www.wv2australia.gov.au/underattack/index.html>

The history of the conflict through Indonesia and New Guinea is summarised here:

<http://www.wv2australia.gov.au/japadvance/>

There is also an item on the coastwatchers and their radios:

<http://www.wv2australia.gov.au/coastwatcher/>

Appendices

- Appendix 1: Eddystone 'All World Two' Instruction Manual
- Appendix 2: Extracts from *Eddystone Short Wave Manual Issue 3* (AW2 Construction and High Frequency Amplifier/Short Wave Converter articles)
- Appendix 3: Extract from *Good Health for South Australia*, Issue 137, 1971, pp 1-6 – more biographical info on Dr. George McQueen
- Appendix 4: AW2 Reviews – *Wireless World*, 1936, *Practical & Amateur Wireless*, 1936
- Appendix 5: Reviews and selection of adverts for the AW2 and related components in *Wireless World*
- Appendix 6: Extracts from the *1936-7 Eddystone Component Catalogue*



Left: the dresser in which the AW2 languished for some 50 years waiting to be switched-on again... the dresser is still being used for outside storage by Ian. If you have a dresser like this lurking in your garage or back porch, for goodness sake check it out – you never know if there will be an Eddystone treasure inside one of the cupboards!



On-air comparison testing between the AW2 and my S.750 and Model 1830/1 receivers (borrowed high-impedance phones)



Restored set (less front panel fixing screws as I needed access to tweak the aerial trimmer, which is rather inconveniently located under the chassis with no means of adjusting with the chassis in its case)

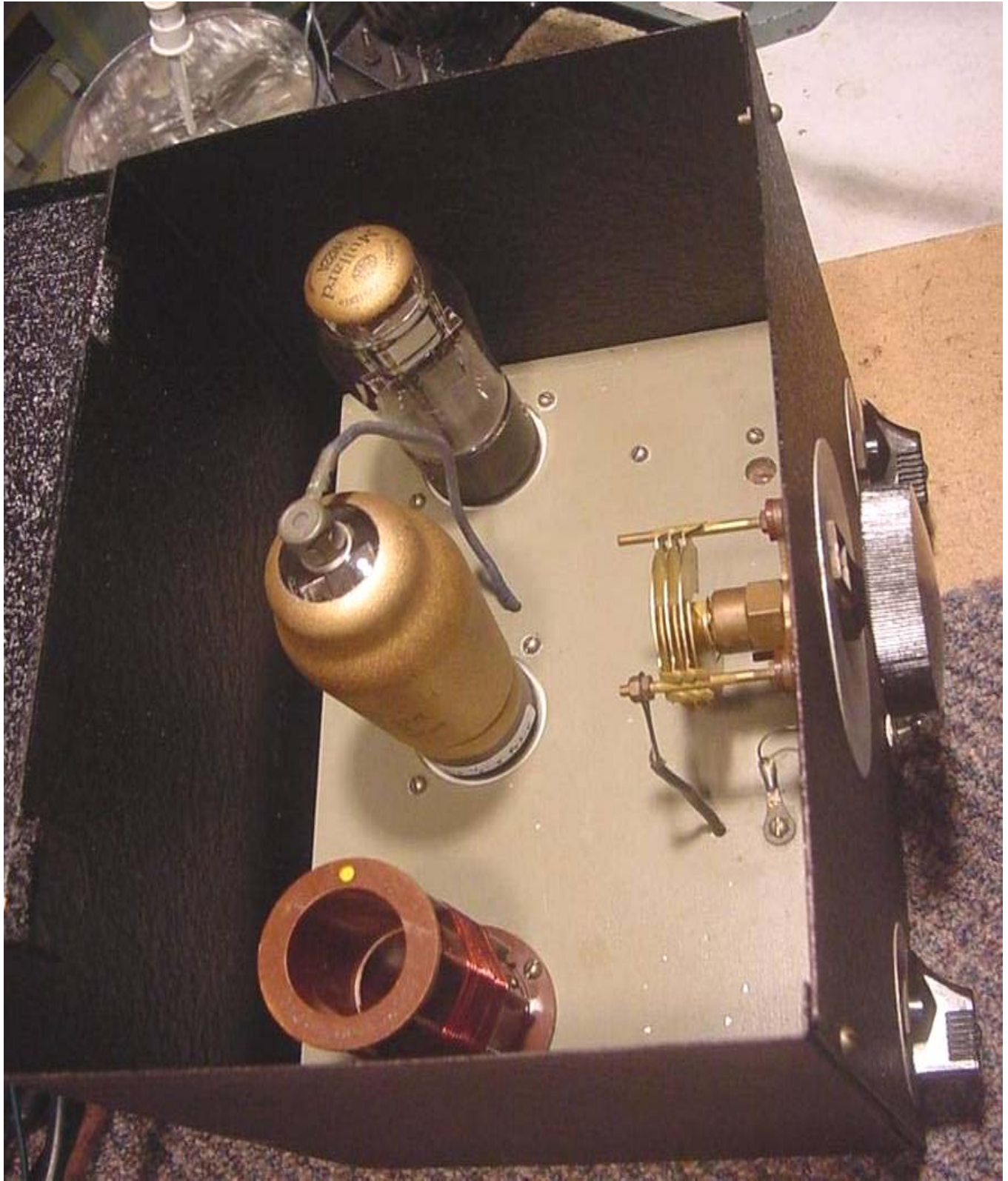

The set with those spanking 'new' Mullards installed – look good eh?

